

# MICRO 5





# MICRO5

We were already small. Now we've gone MICRO.

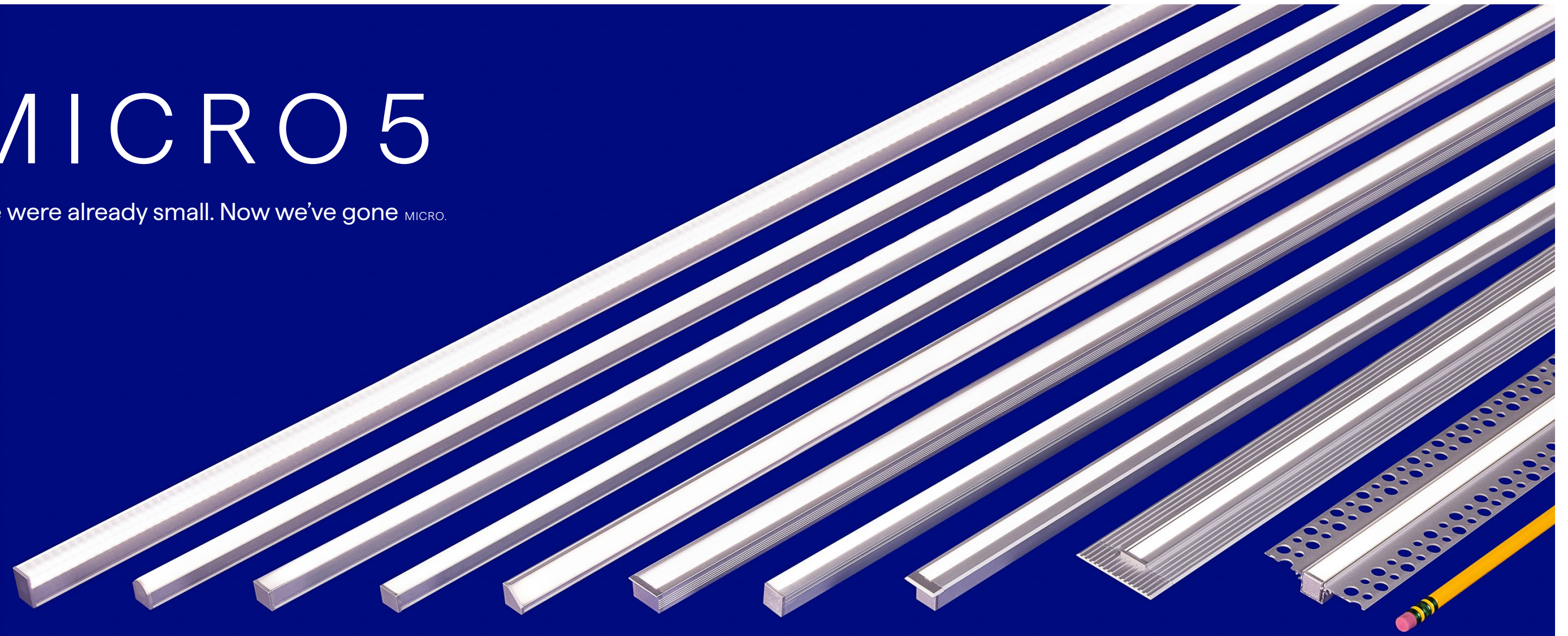

ALTA  
DROP

ALTA  
OPTICS

ALTA  
FLAT

ATOM

TILT

KICKER

POP

POP FLANGE

POP MUD-IN

SLITE

- At less than half the size of our standard fixture offerings, MICRO 5 offers profiles as small as a pencil
- Profiles suit a variety of needs including integration into drywall and angled beams for undershelf and undercabinet purposes
- Smaller form factor integrates into the tightest architectural details
- Mounting hardware options, including stainless steel and magnet clips, ensure optimal installation

Declare.

Red List  
Approved





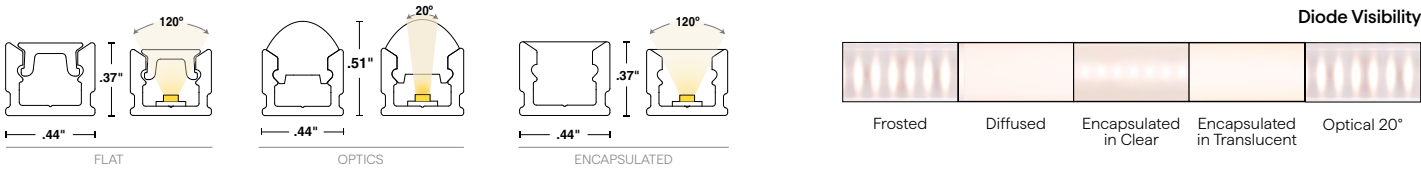
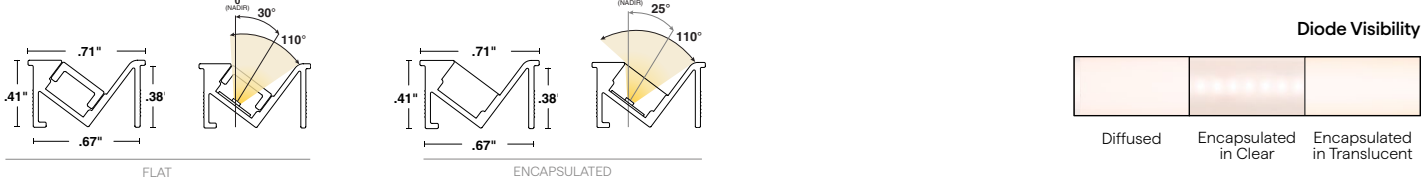
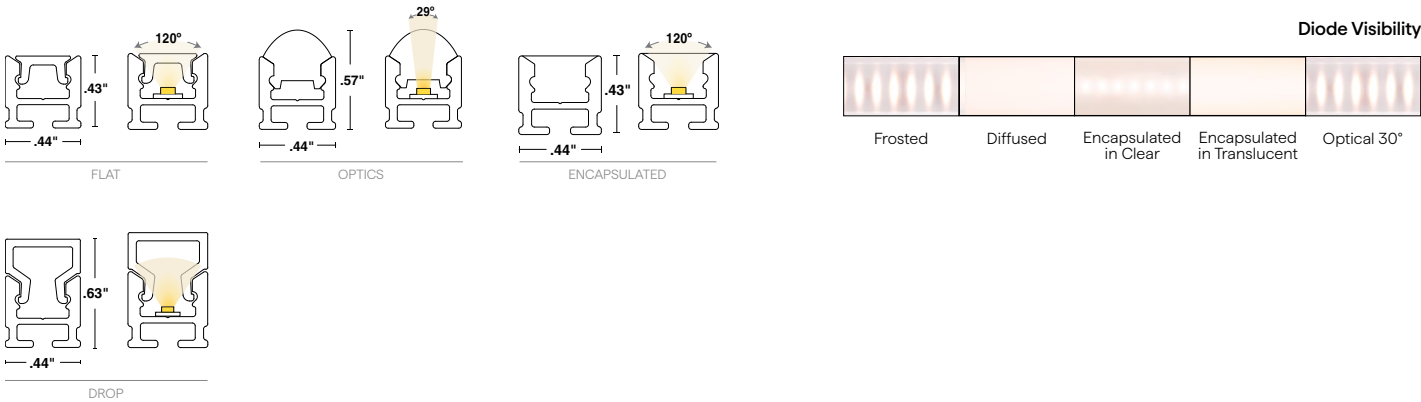

Our unwavering commitment to quality, backed by rigorous manufacturing processes and stringent quality control, has solidified our position as a trusted leader in the lighting industry. Our focus on quality has defined our reputation, and we pledge to deliver the highest-value products and services with a satisfaction guarantee, no matter the job or issue. QTL stands resolute in this promise, taking immense pride in consistently delivering exceptional quality every single day.







## MICRO 5 POP

### Asymmetrical Surface Mount Fixture

The asymmetric fixture allows for light to be thrown at an angle - 80° focused beam 20° off-nadir - without having to install the light at an angle. MICRO 5 POP's minimalist profile blends seamlessly with millwork.

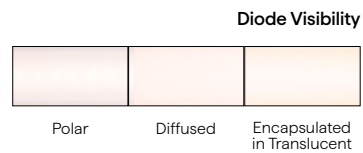
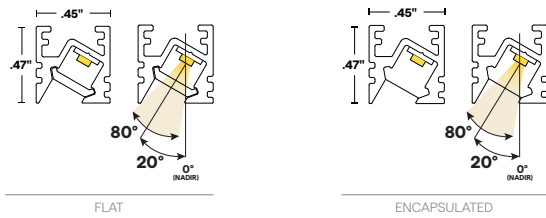

## MICRO 5 POP MUD-IN

### Asymmetrical Recessed Drywall Fixture

The asymmetric fixture allows for light to be thrown at an angle - 80° focused beam 20° off-nadir - without having to install the light at an angle. MICRO 5 POP MUD-IN is offered as a two piece profile, allowing the mud-in channel to be installed into drywall prior to the illuminated fixture's installation.

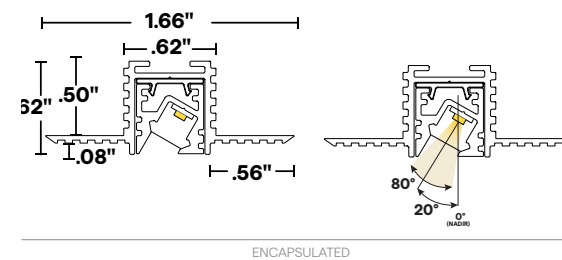
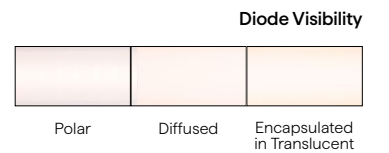
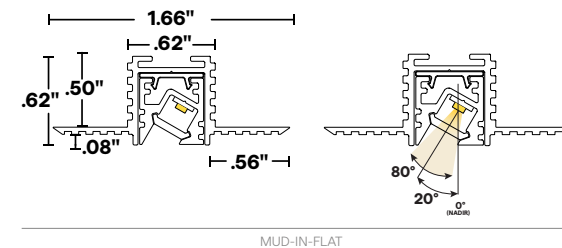

## MICRO 5 POP FLANGE

### Asymmetrical Recess Mount Fixture

The asymmetric fixture allows for light to be thrown at an angle - 75° focused beam 20° off-nadir - without having to install the light at an angle. MICRO 5 POP FLANGE covers substrate imperfections, ensuring a professional finish.

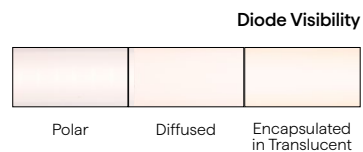
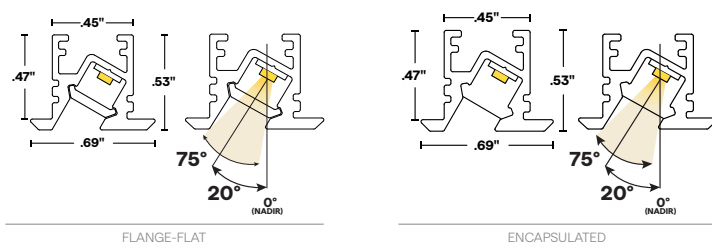

At QTL, enlightened thinking isn't just a philosophy; it's our legacy—one that has consistently garnered industry accolades. From the start of our company over 30 years ago, we relentlessly pursued innovation and continual improvement. These principles drive our development to this day and ensure our significant role in advancing the frontier of the lighting industry.









Product shown: SLITE

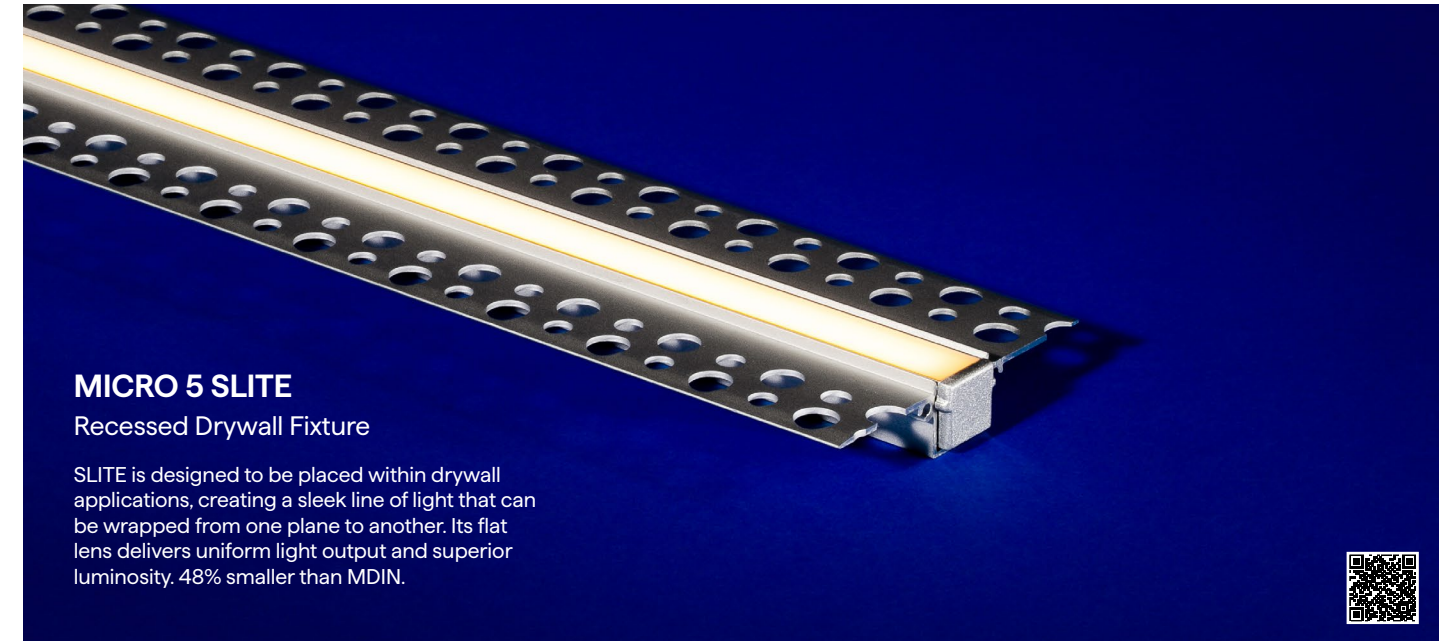

**MICRO 5 SLITE**  
Recessed Drywall Fixture

SLITE is designed to be placed within drywall applications, creating a sleek line of light that can be wrapped from one plane to another. Its flat lens delivers uniform light output and superior luminosity, 48% smaller than MDIN.

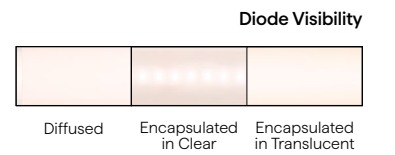
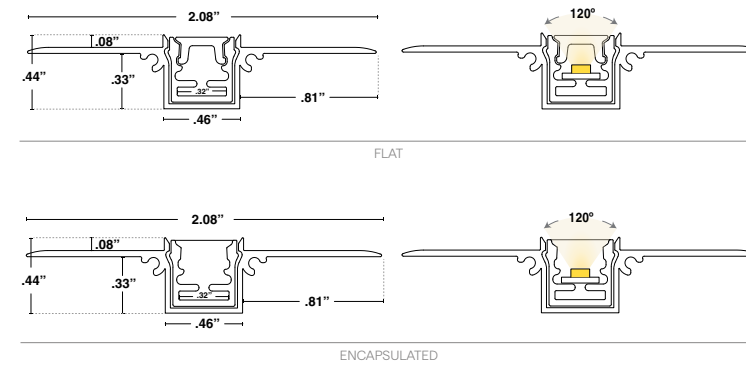

**MICRO 5 TILT**  
Corner Mount Fixture

TILT offers a flat, 45° angled lens that delivers a narrow beam cutoff, making it perfect for applications when the light needs to be flush in a corner. 60% smaller than VEVE.

